



Product Name: ELITE EBW

General information



- This luminaire must be installed in accordance with the latest edition of the IET Wiring Regulations and local Building Regulation by a qualified competent person.
- The mains power supply must be turned off before inspection, installation or removal of the luminaire, ensuring that the supply is locked off to prevent inadvertently switching the supply on.
- It is the installer's responsibility to ensure that the installation is suitable for the total load of the luminaire(s). The supply cable fuses/circuit breakers must be correctly rated for the electrical load and taking into account for any transient inrush currents that may occur.
- It is the installer's responsibility to ensure that the environmental operating and storage conditions are complied with and that any fire risks are considered.
- Do not perform insulation strength or insulation resistance tests on the installation with the luminaire(s) connected, this can damage the luminaires and give erroneous readings.
- Do not loop-in supply cables at the luminaire supply terminals unless there is provision for 2-way connection at the terminals.
- The light source contained in this luminaire must only be replaced by Tamlite Lighting or an appointed service agent.
- Emergency lighting luminaires must be installed and maintained in accordance with the emergency lighting standard BS 5266-1.
- To ensure that the product warranty remains valid, the luminaire must be installed and maintained in accordance with these installation instructions and the product must not be modified in any way.

-  Luminaires marked with this symbol must not be covered with thermally insulating material.
-  This symbol on covers over light sources indicates dangerous live parts do not operate the luminaire with this cover removed.

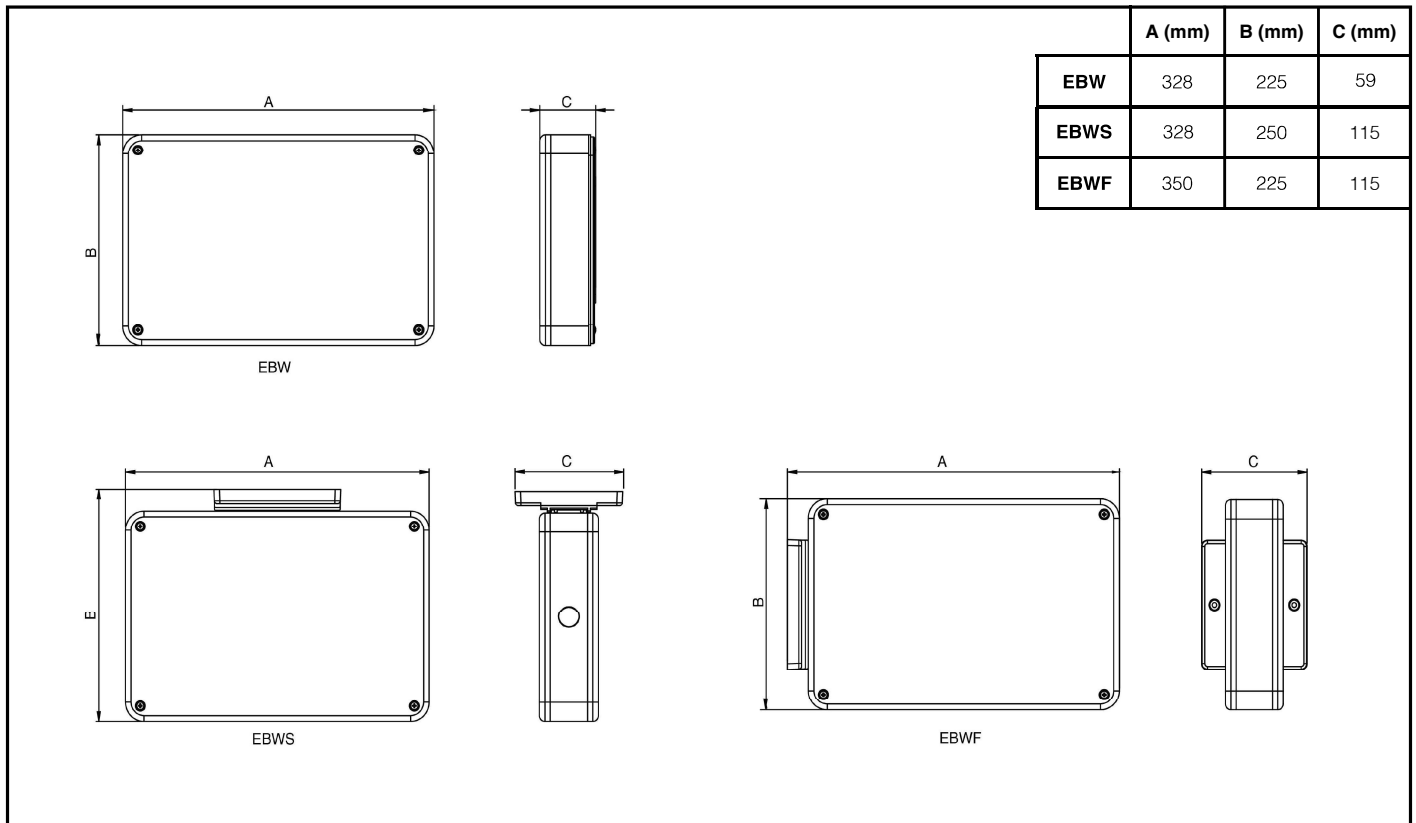
Dimensions

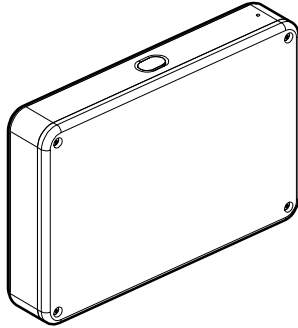
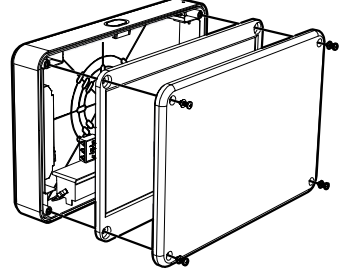
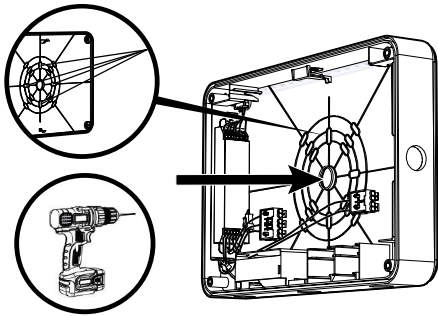
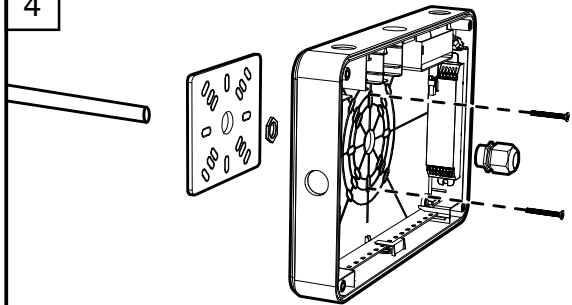
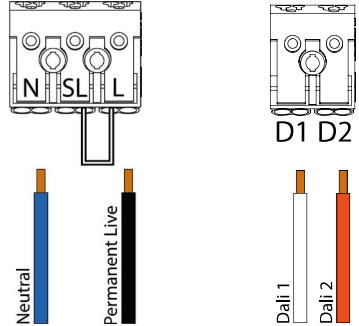
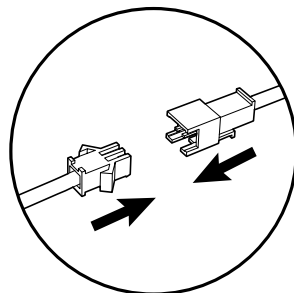
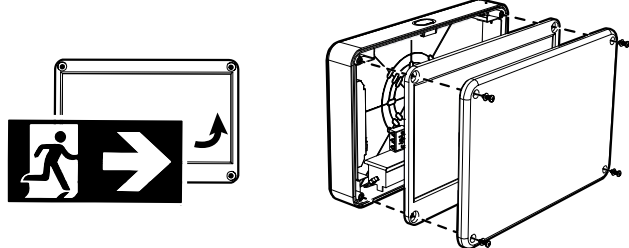

Product Name: ELITE EBW - Surface mounted

<p>1</p>  <p>Remove the product from its packaging.</p>	<p>2</p>  <p>Remove the front diffuser and legend frame.</p>
<p>3</p>  <p>Select and prepare appropriate cable entry and mounting holes.</p>	<p>4</p>  <p>Bring supply cable through the gland and mount with the supplied spacer plate.</p>
<p>5</p>  <p>Terminate supply cable to the terminal block and connect DALI if applicable.</p>	<p>6</p>  <p>Connect the battery connectors.</p>
<p>7</p>  <p>Select the appropriate legend and replace the legend frame and diffuser.</p>	<p>8</p> 

Page 2 of 4

Tamlite Technical
 Stafford Park 12,
 Telford, Shropshire,
 TF3 3BJ

+44(0)1952 292441
 technical@tamlite.co.uk
 Document No: V1

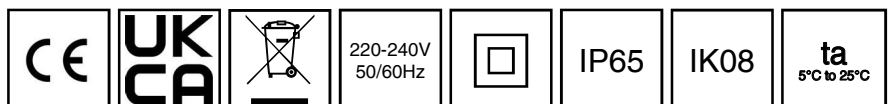

<p>1</p> <p>Remove the product from its packaging.</p>	<p>2</p> <p>Remove the back panel, front diffuser and legend frame.</p>
<p>3</p> <p>Select and prepare an appropriate cable entry hole.</p>	<p>4</p> <p>Connect the ceiling mount with the hardware supplied.</p>
<p>5</p> <p>Bring supply cable through the mount and secure to the surface.</p>	<p>6</p> <p>Terminate supply cable to the terminal block and connect DALI if applicable.</p>
<p>7</p> <p>Select the appropriate legends and replace/install legend frames and diffusers.</p>	<p>8</p>

Product Name: ELITE EBWF - Flag pole mounting

<p>1</p> <p>Remove the product from its packaging.</p>	<p>2</p> <p>Remove the back panel, front diffuser and legend frame.</p>
<p>3</p> <p>Select and prepare an appropriate cable entry hole.</p>	<p>4</p> <p>Connect the ceiling mount with the hardware supplied.</p>
<p>5</p> <p>Bring supply cable through the mount and secure to the surface.</p>	<p>6</p> <p>Terminate supply cable to the terminal block and connect DALI if applicable.</p>
<p>7</p> <p>Select the appropriate legends and replace/install legend frames and diffusers.</p>	<p>8</p>